

226/Z
226/Z-DT

226/Z-TF

226/Z-TF-FEP

226/Z-DS

LAMPENFASSUNG FÜR HALOGENHOCHVOLTlampEN

LAMP HOLDERS FOR MAIN VOLTAGE TUNGSTEN HALOGEN INCANDESCENT LAMPS

Technische Daten

Technical data







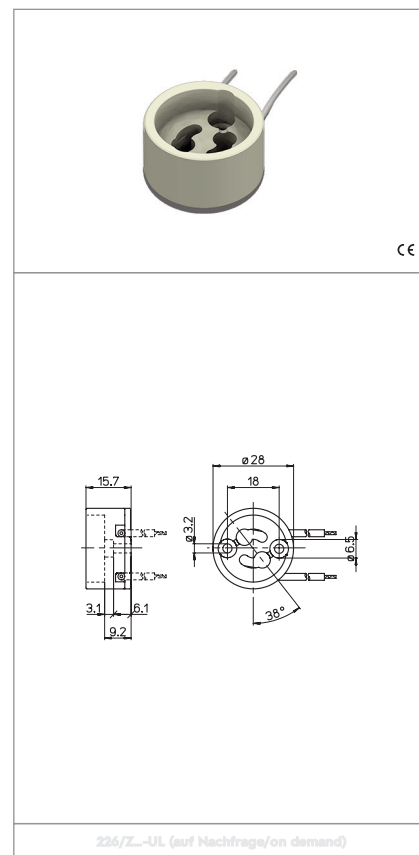

- LAMPENSOCKEL - Lamp cap	GU10 GZ10
- Nennstrom und Nennspannung - Rated current and voltage	2A-250V
- Maximale Betriebstemperatur (IEC) - Maximum operating temperature (IEC)	T250
- Schutzgrad - Protection index	IP20
- Überspannungskategorie - Impulse withstand category	II

Merkmale

Characteristics

- Steatit Gehäuse
- Steatite body
- Gehäuse aus PPS, T240
- Black PPS base (TI= 240 °C)
- Nickel Kontakt
- Nickel contacts



 Schraubbefestigung screw fixing	 an leitung punktgeschweisster Kontakt conductor electrically spot-welded to the contact	 Bereich mehrdrige Leitungen mit Aderendhülsen section of the flexible conductor with ferrule SIL 1	 Bereich mehrdrige Leitungen mit Aderendhülsen section of the flexible conductor with ferrule TF 1
 Bereich mehrdrige Leitungen mit Aderendhülsen section of the flexible conductor with ferrule FEP 1	 Bereich mehrdrige Leitungen mit Aderendhülsen section of the flexible conductor with ferrule DS 1	 Bereich mehrdrige Leitungen mit Aderendhülsen section of the flexible conductor with ferrule DT 0,75	 Leitungslänge flexibel flexible wire length 14 cm
 118/...			

Prüfzeichen
Quality marks

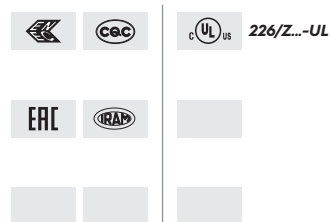

Europäische Richtlinien
European directives

gemäß "RoHS"
"RoHS" compliant
unterliegt nicht "WEEE"
Not subject to "WEEE"

Gewichte und Verpackung
Weights and packaging

Artikel/Art. Produktinweise Product references	g Nettogewicht Net weight	n° pz pro Beutel per bag	n° pz pro Box per box	n° pz pro Karton per carton
226/Z	17,7		200	
226/Z-TF	17		200	
226/Z-TF-FEP	16,7		200	
226/Z-DS	20,3		200	
226/Z-DT	17,3		200	600

Bemerkung

Notes

Bemerkung

Note

ARTIKEL AUS STEATIT

Produkte, die aus Steatit formgespritzt sind, durchlaufen dimensionale Veränderungen bei durch Austrocknung bei hohen Temperaturen. Daher ist ein Hinweis auf die in DIN40680 angegebenen Toleranzen anzugeben, Mittelwert bezogen auf die Nennwerte gemäß Angabe im Katalog.

ARTICLES IN STEATITE

Products moulded in steatite undergo dimensional changes during the high temperature curing process. Therefore reference must be made to the tolerance stated in DIN 40680, middle values referred to the nominal values stated in the catalogue.

ABMESSUNGEN DIMENSIONS	Toleranzen/Tolerance
	DIN40680
Fino a/Up to 4	±0,15
Von/From 4,1 bis/to 6	±0,20
Von/From 6,1 bis/to 8	±0,25
Von/From 8,1 bis/to 10	±0,30
Von/From 10,1 bis/to 13	±0,35
Von/From 13,1 bis/to 16	±0,40
Von/From 16,1 bis/to 20	±0,45
Von/From 20,1 bis/to 25	±0,50
Von/From 25,1 bis/to 30	±0,55
Von/From 30,1 bis/to 35	±0,60
Von/From 35,1 bis/to 40	±0,65
Von/From 40,1 bis/to 45	±0,70
Von/From 45,1 bis/to 50	±0,80
Von/From 50,1 bis/to 55	±0,90
Von/From 55,1 bis/to 60	±1,00